

CURRENT 1.0 Ampere
 VOLTAGE RANG 50 to 1000 Volts

US1AF THRU US1MF

Features

- Glass Passivated Die Construction
- Diffused Junction
- Ultra-Fast Recovery Time for High Efficiency
- Low Forward Voltage Drop, High Current Capability, and Low Power Loss
- Ideally Suited for Automated Assembly

SMAF

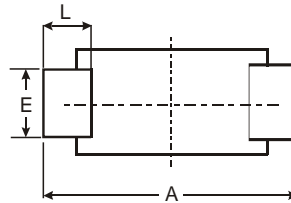
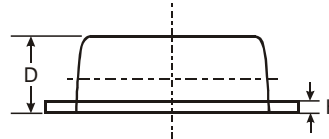
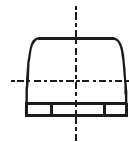
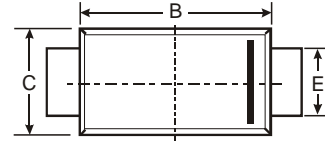

Dim	Min	Max	Typ
A	4.75	4.85	4.80
B	3.68	3.72	3.70
C	2.57	2.63	2.60
D	0.097	1.03	1.00
E	1.38	1.42	1.40
H	0.13	0.17	0.15
L	0.63	0.67	0.65
All Dimensions in mm			

Mechanical Data

- Case: SMAF, Molded Plastic
- Terminals: Solder Plated, Solderable per MIL-STD-750, Method 2026
- Polarity: Color band denotes cathode end
- Mounting Position: Any
- Weight: 0.0018 ounce, 0.062 grams

Maximum Ratings and Electrical Characteristics

T_A = 25°C unless otherwise specified

Single phase, half wave, 60Hz, resistive or inductive load. For capacitive load, derate current by 20%.

Characteristic	Symbol	US1AF	US1BF	US1DF	US1GF	US1JF	US1KF	US1MF	Unit	
Peak Repetitive Reverse Voltage Working Peak Reverse Voltage DC Blocking Voltage	V _{RRM} V _{RWM} V _R	50	100	200	400	600	800	1000	V	
RMS Reverse Voltage	V _{R(RMS)}	35	70	140	280	420	560	700	V	
Average Rectified Output Current @ T _T = 75°C	I _O	1.0							A	
Non-Repetitive Peak Forward Surge Current 8.3ms Single half sine-wave Superimposed on Rated Load (JEDEC Method)	I _{FSM}	30							A	
Forward Voltage Drop @ I _F = 1.0A	V _{FM}	1.0		1.3		1.7			V	
Peak Reverse Current @ T _A = 25°C at Rated DC Blocking Voltage @ T _A = 100°C	I _{RM}	5.0				100				μA
Reverse Recovery Time (Note 2)	t _{rr}	50				75				ns
Typical Junction Capacitance (Note 1)	C _j	20				10				pF
Typical Thermal Resistance, Junction to Terminal	R _{θJT}	30							°C/W	
Operating and Storage Temperature Range	T _j , T _{STG}	-65 to +150							°C	

- Notes:
1. Measured at 1.0MHz and applied reverse voltage of 4.0V DC.
 2. Measured with I_F = 0.5A, I_R = 1.0A, I_{rr} = 0.25A.

CURRENT 1.0 Ampere
 VOLTAGE RANG 50 to 1000 Volts

US1AF THRU US1MF

RATING AND CHARACTERISTIC CURVES US1AF Thru US1MF

Fig. 1 Forward Current Derating Curve

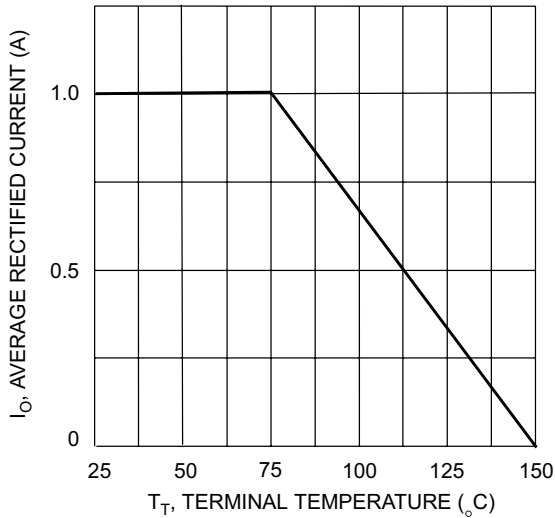

Fig. 2 Typical Forward Characteristics

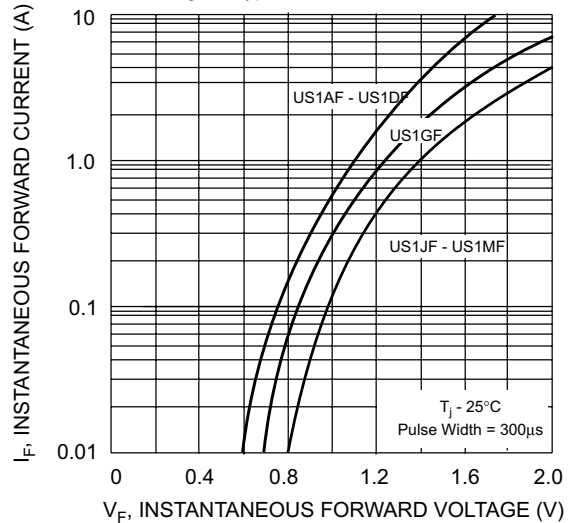

Fig. 3 Forward Surge Current Derating Curve

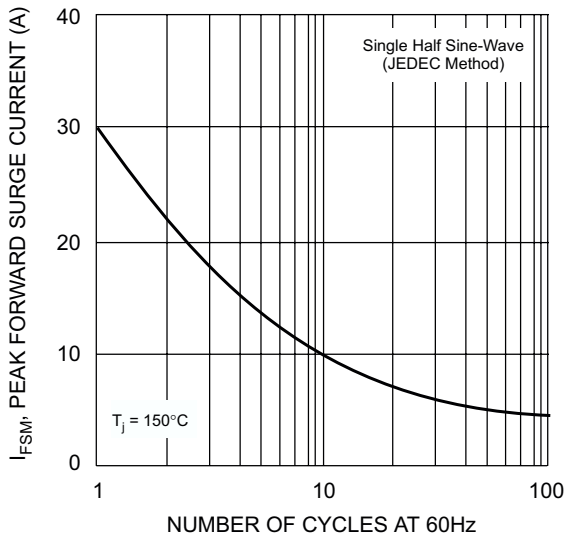

Fig. 4 Typical Reverse Characteristics

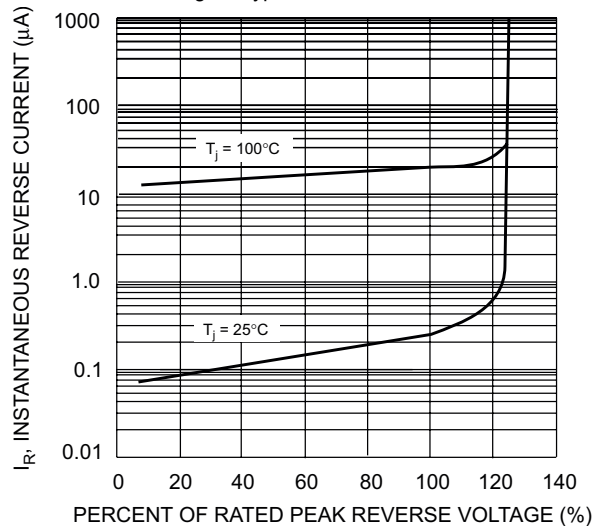
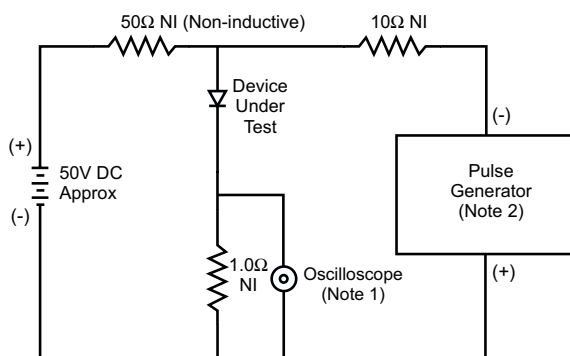

Fig. 5 Reverse Recovery Time Characteristic and Test Circuit



- Notes:
 1. Rise Time = 7.0ns max. Input Impedance = 1.0MΩ, 22pF.
 2. Rise Time = 10ns max. Input Impedance = 50Ω.

