

CURRENT 20 Ampere
VOLTAGE RANG 200 to 1000 Volts

SFP2002 THRU SFP2010

Features

- * Fast switching for high efficiency
- * Low forward voltage drop
- * High current capability
- * Low reverse leakage current
- * High surge current capability

Application

- * Automotive Inverters and Solar Inverters
- * Plating Power Supply, Motor Control, SMPS and UPS
- * Car Audio Amplifiers and Sound Device Systems

Mechanical Data

- * Case: Heatsink TO-247AD/247S/3P open metal package
- * Epoxy: UL 94V-0 rate flame retardant
- * Terminals: Solderable per MIL-STD-202 method 208
- * Polarity: As marked on diode body
- * Mounting position: Any
- * Weight: 0.65 gram approximately

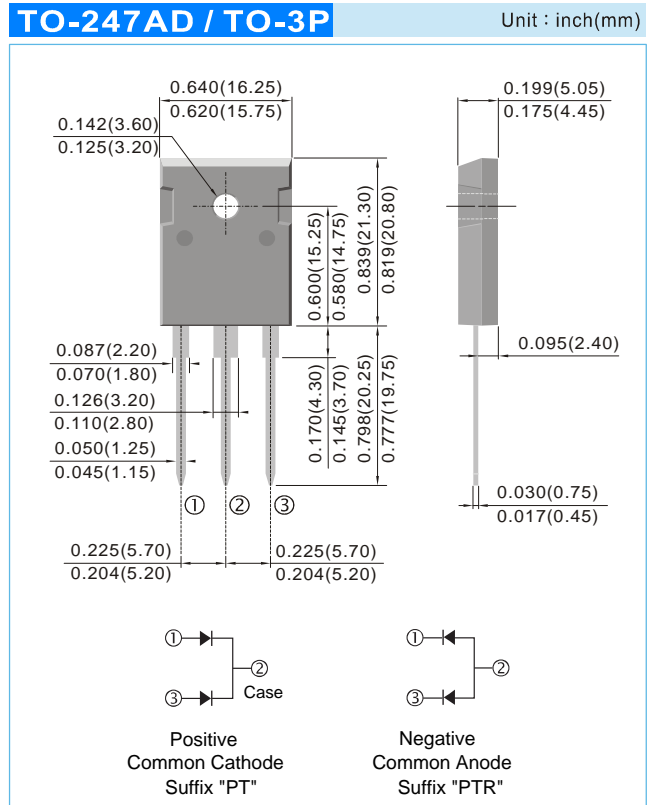

MAXIMUM RATINGS AND ELECTRICAL CHARACTERISTICS

Rating at 25°C ambient temperature unless otherwise specified.
Single phase, half wave, 60Hz, resistive or inductive load.
For capacitive load, derate current by 20%.

	SYMBOL	SFP2002	SFP2004	SFP2006	SFP2008	SFP2010	UNIT
Maximum Recurrent Peak Reverse Voltage	VRRM	200	400	600	800	1000	V
Maximum RMS Voltage	VRMS	140	280	420	560	700	V
Maximum DC Blocking Voltage	VDC	200	400	600	800	1000	V
Maximum Average Forward Rectified Current Tc=125°C (Total Device 2x10A=20A)	IF(AV)	20.0					A
Peak Forward Surge Current, 8.3ms single Half sine-wave superimposed on rated load (JEDEC method)	IFSM	200					A
Maximum Instantaneous Forward Voltage @ 10.0 A (Per Diode/Per Leg)	VF	0.98	1.3	1.5	1.7	1.9	V
Maximum DC Reverse Current @Tj=25°C At Rated DC Blocking Voltage @Tj=125°C	IR	10 500					uA uA
Maximum Reverse Recovery Time (Note 1)	Trr	35			50		nS
Typical junction Capacitance (Note 2)	CJ	85					pF
Operating Junction and Storage Temperature Range	TJ, TSTG	-55 to +150					°C

NOTES : (1) Reverse recovery test conditions $I_F = 0.5A$ $I_R = 1.0A$ $I_{rr} = 0.25A$.

(2) Thermal Resistance junction to terminal.

(3) Measured at 1.0 MHz and applied reverse voltage of 4.0 Volts DC.

CURRENT 20 Ampere
 VOLTAGE RANG 200 to 1000 Volts

SFP2002 THRU SFP2010

RATING AND CHARACTERISTIC CURVES

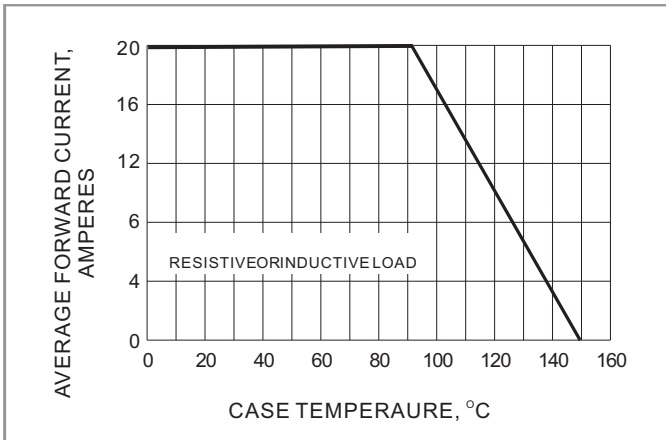

Fig.1- FORWARD CURRENT DERATING CURVE

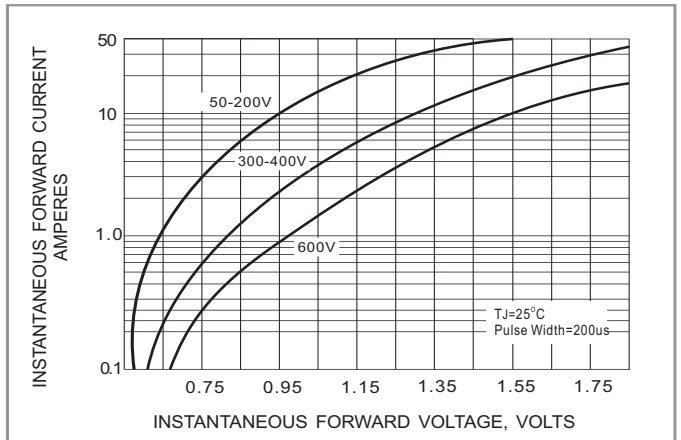

Fig.2- TYPICAL INSTANTANEOUS FORWARD CHARACTERISTIC

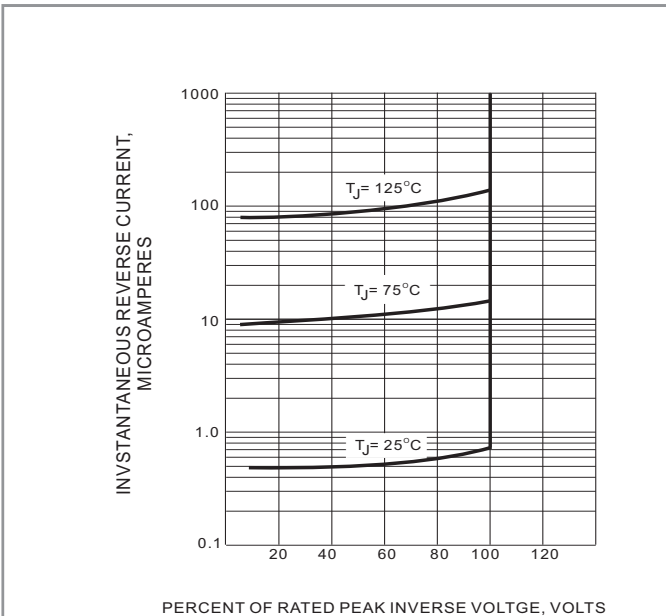

FIG.3 TYPICAL REVERSE CHARACTERISTICS

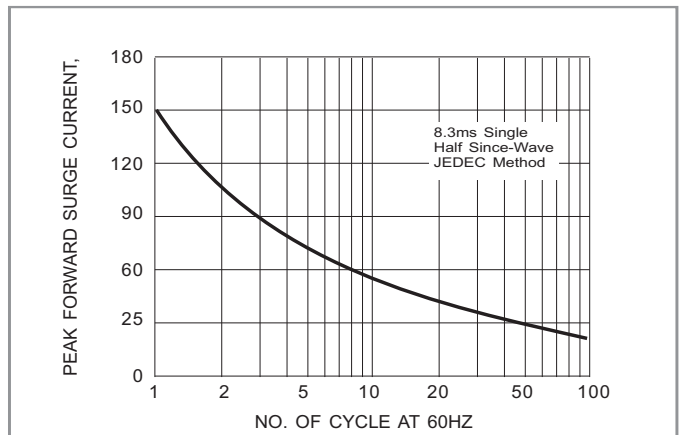

Fig.4- MAXIMUM NON - REPETITIVE SURGE CURRENT

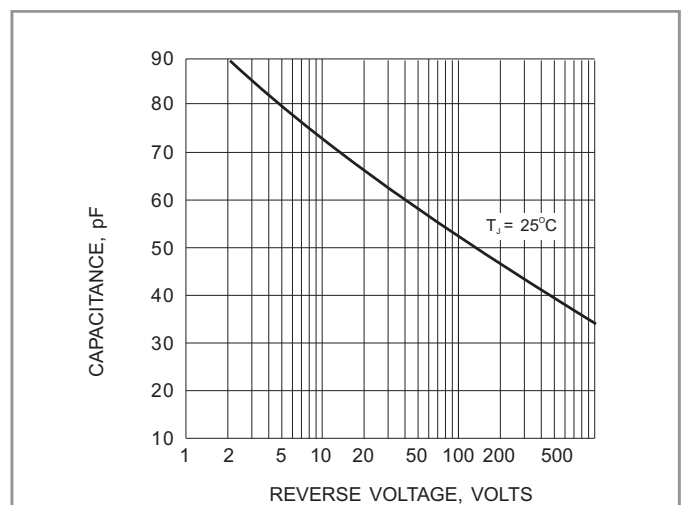
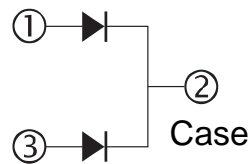
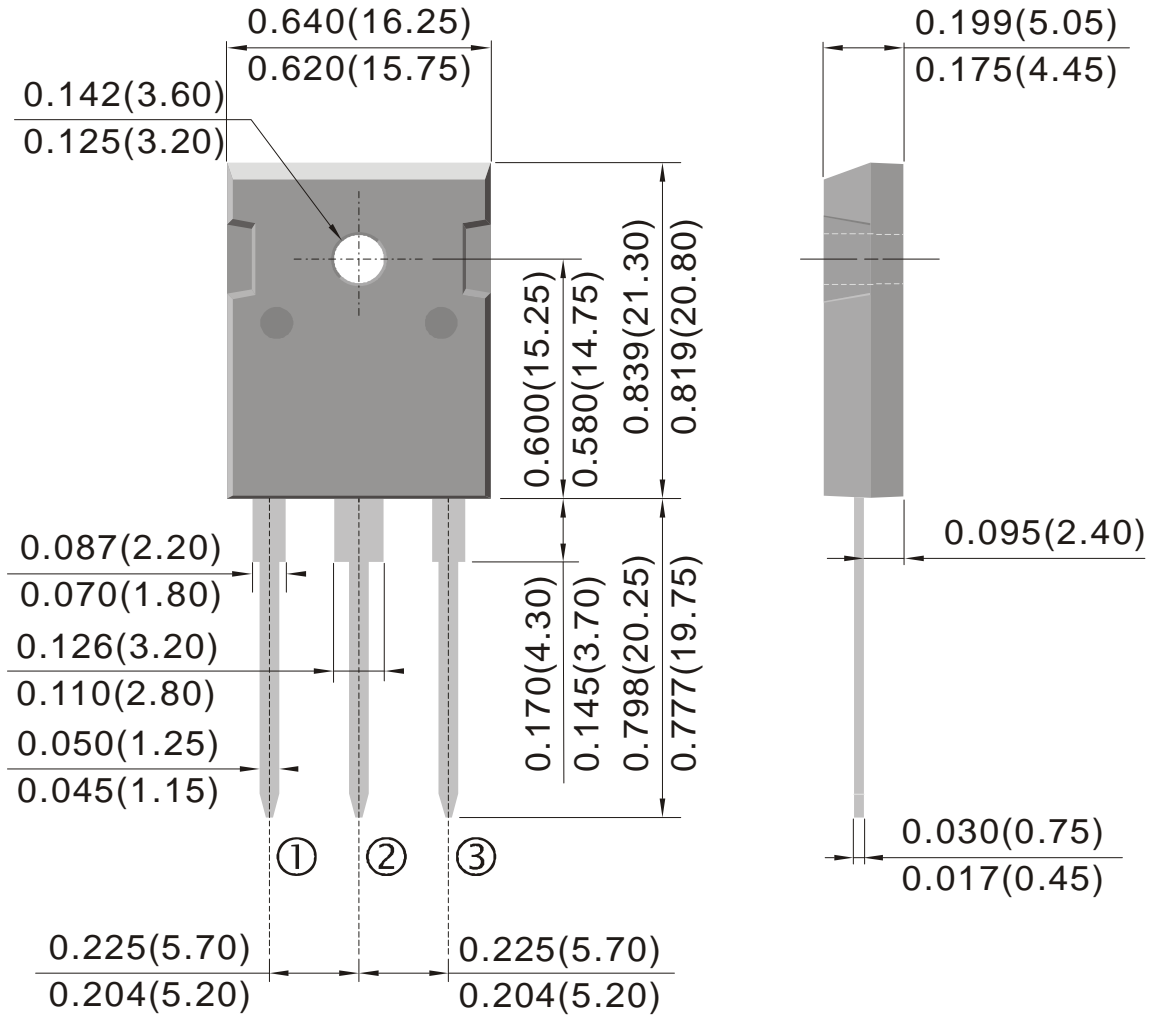

Fig.5- TYPICAL JUNCTION CAPACITANCE

CURRENT 20 Ampere
 VOLTAGE RANG 200 to 1000 Volts

SFP2002 THRU SFP2010

T0-247AD



Positive
 Common Cathode
 Suffix "PT"

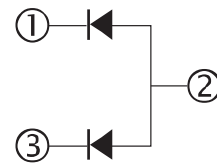

Negative
 Common Anode
 Suffix "PTR"

CURRENT 20 Ampere
 VOLTAGE RANG 200 to 1000 Volts

SFP2002 THRU SFP2010

T0-247S

Ref.	Dimensions					
	Millimeters			Inches		
	Min.	Typ.	Max.	Min.	Typ.	Max.
A	4.85		5.16	0.191		0.203
D	2.20		2.60	0.086		0.102
E	0.40		0.80	0.015		0.031
F	1.00		1.40	0.039		0.055
F1		3.00			0.118	
F2		2.00			0.079	
F3	1.90		2.40	0.075		0.094
F4	3.00		3.40	0.118		0.134
G		10.90			0.429	
H	15.45		16.03	0.608		0.631
L	19.85		21.09	0.781		0.830
L1	3.70		4.30	0.146		0.169
L2	18.30		19.13	0.720		0.753
L3	14.20		20.30	0.559		0.799
L4	34.05		41.38	1.341		1.629
L5	5.35		6.30	0.211		0.248
M	2.00		3.00	0.079		0.118
V		5°			5°	
V2		60°			60°	
Dia.	3.55		3.65	0.140		0.144

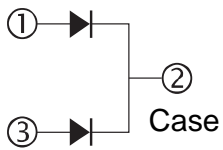

Positive
Common Cathode
Suffix "PT"

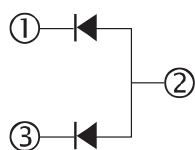

Negative
Common Anode
Suffix "PTR"

