

CURRENT 10 Ampere
 VOLTAGE RANG 45 to 100 Volts

ER10V45GY THRU ER10V100GY

FEATURE

- . For surface mounted application
- . High current capability
- . Low forward voltage drop
- . Low power loss, high efficiency
- . High surge current capability
- . High temperature soldering guaranteed:
 260°C/10 seconds at terminals.

MECHANICAL DATA

- . Terminal: Solder plated
- . Case: Molded with UL-94 Class V-0 recognized
 Flame Retardant Epoxy

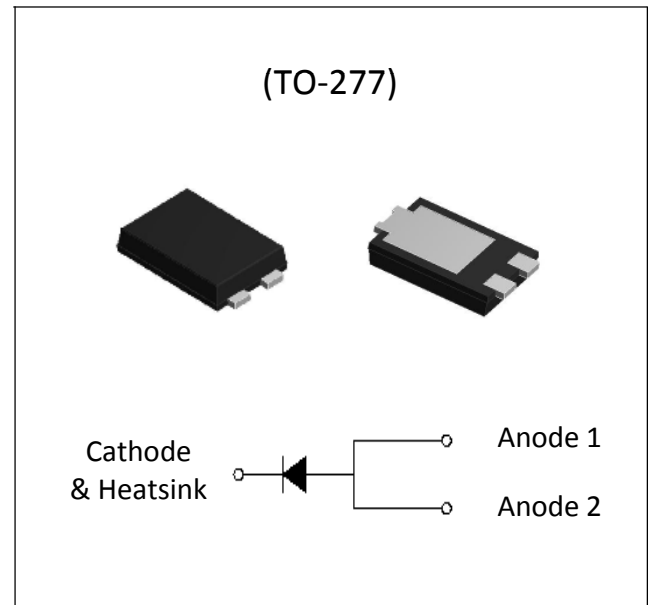

MAXIMUM RATINGS AND ELECTRICAL CHARACTERISTICS

Ratings at 25°C ambient temperature unless otherwise specified.

Single phase, half wave, 60Hz, resistive or inductive load. For capacitive load, derate current by 20%

Type Number		SYMBOL	10V45	10V60	10V80	10V100	units
Maximum Recurrent Peak Reverse Voltage		V_{RRM}	45	60	80	100	V
Maximum RMS Voltage		V_{RMS}	31.5	42	56	70	V
Maximum DC blocking Voltage		V_{DC}	45	60	80	100	V
Average Forward Rectified Output Current		$I_{F(AV)}$	10.0				A
Peak Forward Surge Current 8.3ms single half sine-wave superimposed on rated load (JEDEC method)		I_{FSM}	200.0				A
Maximum Instantaneous Forward Voltage at 2.0A DC	@ $T_A=25^\circ C$	V_F	0.28	0.33	0.38	0.42	V
Maximum Instantaneous Forward Voltage at 10.0A DC	@ $T_A=100^\circ C$		0.20	0.24	0.30	0.35	
Maximum Instantaneous Forward Voltage at 2.0A DC	@ $T_A=25^\circ C$		0.38	0.44	0.52	0.56	
Maximum Instantaneous Forward Voltage at 10.0A DC	@ $T_A=100^\circ C$		0.32	0.38	0.45	0.50	
Maximum DC Reverse Current at rated DC blocking voltage	@ $T_A=25^\circ C$	I_R	0.02	0.03	0.05	0.05	mA
	@ $T_A=100^\circ C$		5.0	5.0	10.0	10.0	
Typical Junction Capacitance (Note1)		C_J	600				pF
Typical Thermal Resistance (Note2)		$R_{(JA)}$	31				°C/W
Storage Temperature		T_{STG}	-55 to +150				°C
Operating Junction Temperature		T_J	-55 to +150				°C

Note: 1. Measured at 1.0 MHz and applied reverse voltage of 4.0Vdc

2. Polyimide PCB, 2oz. Copper. Cathode pad dimensions 18.8mm x 14.4mm. Anode pad dimensions 5.6mm x 14.4mm.

CURRENT 10 Ampere
 VOLTAGE RANG 45 to 100 Volts

ER10V45GY THRU ER10V100GY

RATING AND CHARACTERISTIC CURVES

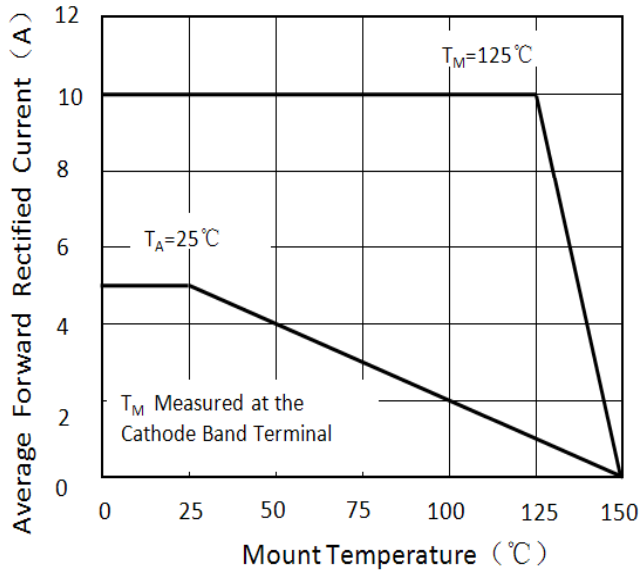

Figure 1. Forward Current Derating Curve

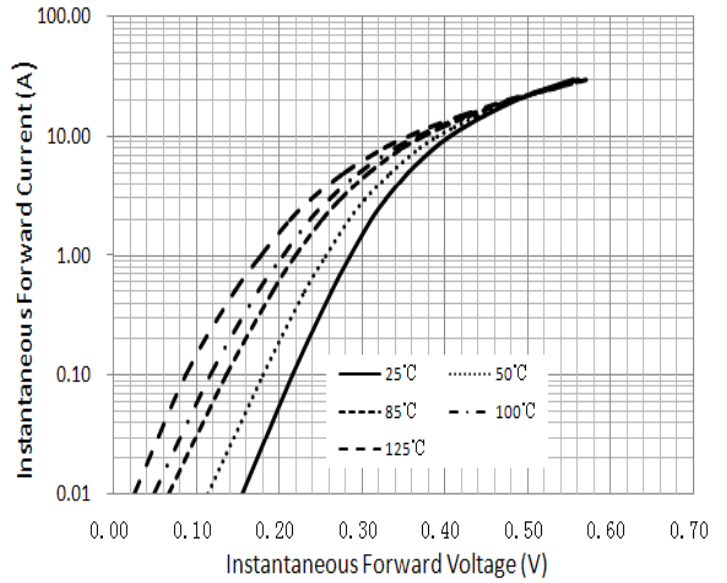

Figure 2. Typical Instantaneous Forward Characteristics

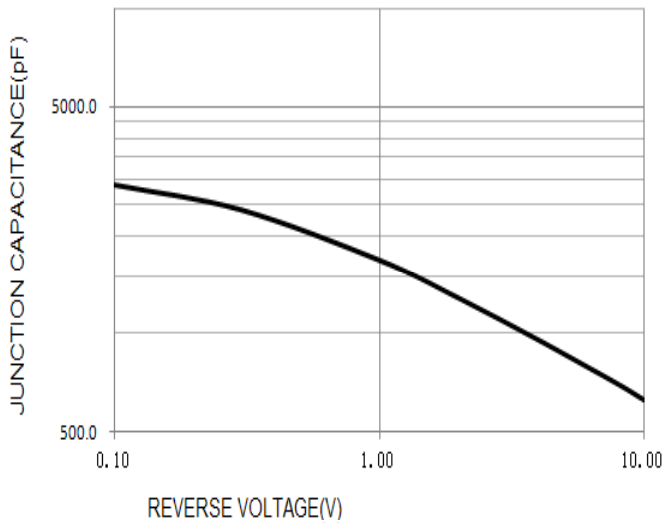

Figure 3. Typical Junction Capacitance

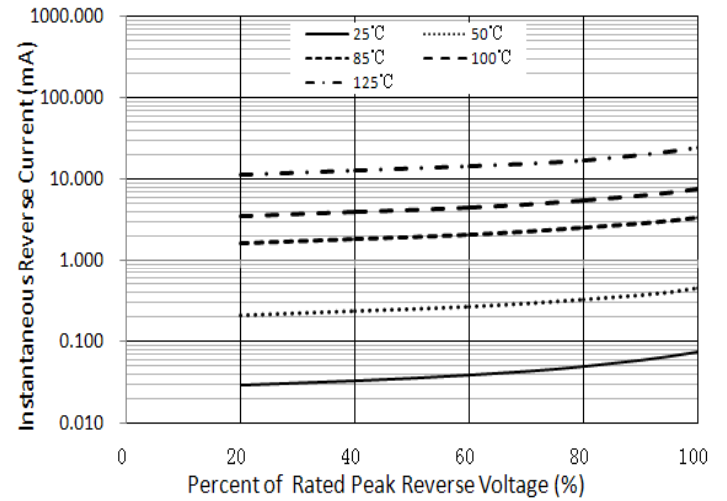

Figure 4. Typical Reverse Characteristics

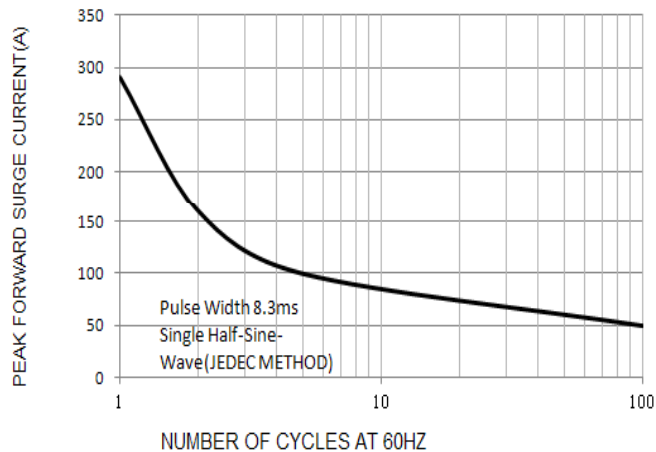
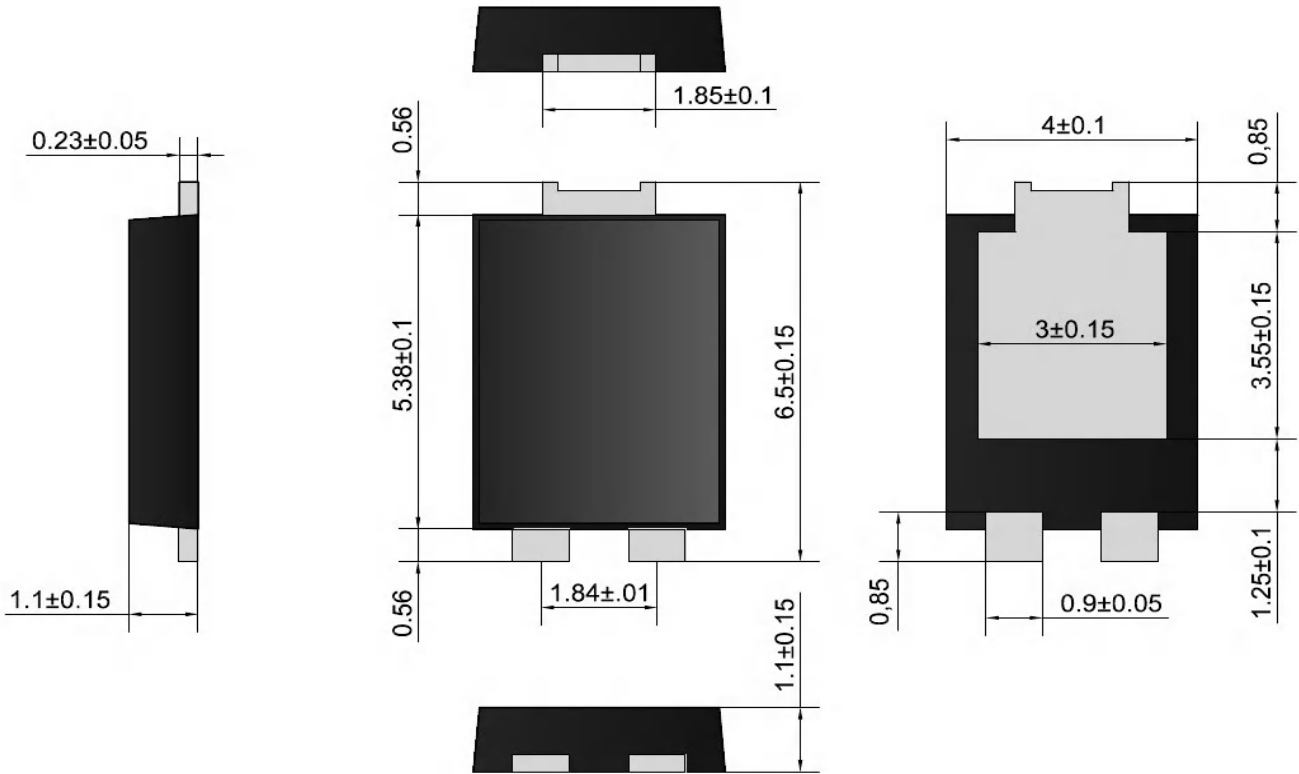

Figure 5. Maximum Non-Repetitive Peak Forward Surge Current

CURRENT 10 Ampere
 VOLTAGE RANG 45 to 100 Volts

ER10V45GY THRU ER10V100GY

PACKAGE OUTLINE DIMENSIONS



Packaging

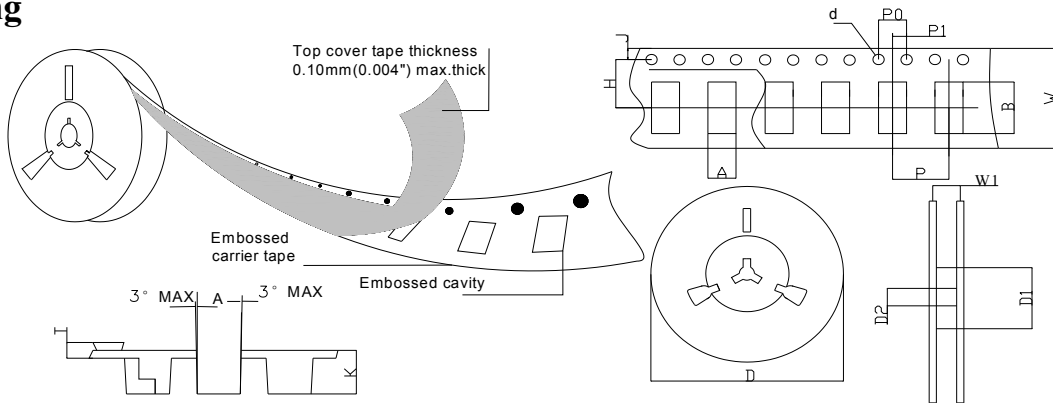

SPECIFICATIONS mm(inch)		PACKAGE	SPECIFICATIONS mm(inch)		PACKAGE
ITEM	SYM BOL	PS-277B	ITEM	SYM BOL	PS-277B
Carrier width	A	4.45(0.175)Max	Carrier depth	K	1.60(0.063)Typ
Carrier length	B	7.0(0.276)Max	Punch hole pitch	P	8.00(0.315)Typ
Sprocket hole	d	ø1.55(0.061)Typ	Sprocket hole pitch	P0	4.00(0.157)Typ
Reel outer diameter	D	330.0(13.0)Typ	Embossment center	P1	2.00(0.079)Typ
Reel inner diameter	D1	74.0(2.913)Min	Overall tape thickness	T	0.25(0.010)Typ
Feed hole diameter	D2	13.0(0.512)Typ	Tape width	W	16.0(0.630)Typ
Sprocket hole position	J	1.75(0.069)Typ	Reel width	W1	16.5(0.650)Min
Punch hole position	H	7.50(0.295)Typ			